

iWash S-12

Electronic Bidet Seat

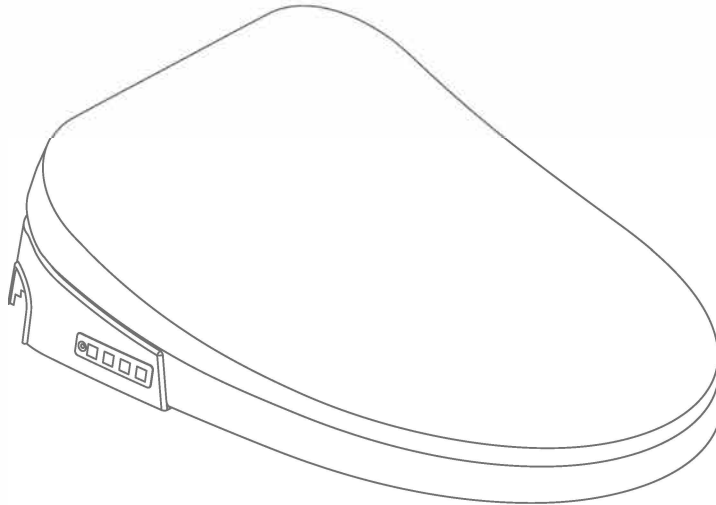

Installation & User Guide

Read all operating instructions before installation and use.

Please save this instruction manual and place in an easily accessible location.

External appearance and specifications are subject to change

for improvement of product without notice.

Table of Contents

SAFETY PRECAUTIONS.....	1	CLEANING INSTRUCTIONS.....	15
PARTS IDENTIFICATION.....	8	TROUBLESHOOTING.....	16
INSTALLATION.....	10	REMOTE PAIRING.....	17
REMOTE GUIDE.....	13	SPECIFICATIONS.....	18
SEAT PANEL GUIDE.....	14	WARRANTY INFO.....	19

IMPORTANT SAFETY INSTRUCTIONS

When using electronic appliances, especially when children are present, basic safety precautions should always be followed.

READ ALL INSTRUCTIONS BEFORE USE

DANGER - As with most electronic appliances, electrical parts are live even when the appliance is powered off. To reduce risk of death by electric shock:

1. Do not use while bathing.
2. Do not place or store appliance where it can fall or be pulled into a tub or sink.
3. Do not place in or drop into water or any other liquid.
4. If an appliance falls in water, unplug it immediately. Do not reach into the water.

WARNING -To reduce risk of burns, electrocution, fire or injury to persons:

1. Close supervision is necessary when this appliance is used by, on or near children or handicapped persons.
2. Use this appliance only for its intended use as described in this manual. Do not use any attachments not recommended by the manufacturer.
3. Never operate this appliance if it has a damaged cord or plug, if it is not working properly, or if it has been dropped, damaged, or dropper into water. Contact Icera Customer Service for examination, repair and/or replacement.
4. Keep the cord away from heated surfaces. Do not wrap the cord around the appliance.
5. Never block the air openings of the appliance or place it on a soft surface, such as a bed or couch, where the air openings may be blocked. Keep the air openings free of lint, hair and other debris.
6. Never drop or insert any object into any opening or hose.
7. Do not use outdoors or operate where aerosol (spray) products are being used or where oxygen is being administered.
8. Do not use an extension cord with this appliance.
9. Use this appliance only for household use.
10. Connect this product to a properly grounded outlet only. See Grounding Instructions for further details.

CONSIGNES DE SECURITE IMPORTANTES

Lors de l'utilisation d'appareils électroniques, en particulier en presence d'enfants, des precautions de securite de base doivent toujours etre respectees.

LISEZ TOUTES LES INSTRUCTIONS AVANT UTILISATION

DANGER -Comme avec la plupart des appareils électroniques, les pieces electriques sont sous tension meme lorsque l'appareil est hors tension. Pour reduire le risque de deces par choc electrique:

1. Ne pas utiliser pendant le bain.
2. Ne placez pas et ne stockez pas l'appareil ou il peut tomber ou etre tire dans une baignoire ou un evier.
3. Ne pas placer dans ou tomber dans l'eau ou tout autre liquide.
4. Si un appareil tombe dans l'eau, debranchez-le immediatement. Ne mettez pas la main dans l'eau.

AVERTISSEMENT -Pour reduire les risques de brulures, d'electrocution, d'incendie ou de blessures corporelles:



1. Une surveillance etroite est necessaire lorsque cet appareil est utilise par, sur ou a proximite d'enfants ou d'invalides.
2. N'utilisez cet appareil que pour l'usage auquel il est destine, comme decrit dans ce manuel. N'utilisez aucun accessoire non recommande par le fabricant.
3. N'utilisez jamais cet appareil s'il a un cordon ou une fiche endommage, s'il ne fonctionne pas correctement, ou s'il a ete echappe, endommage ou tombe dans l'eau. Contactez le service client Icera pour un examen, une reparation et/ ou un remplacement.
4. Gardez le cordon loin des surfaces chauffees. N'enroulez pas le cordon autour de l'appareil.
5. Ne bloquez jamais les ouvertures d'air de l'appareil et ne le placez pas sur une surface molle, comme un lit ou un canape, ou les ouvertures d'air peuvent etre bloquees. Gardez les ouvertures d'air exemptes de peluches, cheveux et autres debris.
6. Ne laissez jamais tomber ou n'inserez aucun objet dans une ouverture ou un tuyau.
7. Ne pas utiliser a l'exterieur ni utiliser la ou des produits aerosols (aerosols) sont utilises ou de l'oxygene est administre.
8. N'utilisez pas de rallonge avec cet appareil.
9. Utilisez cet appareil uniquement pour un usage domestique.
10. Connectez ce produit a une prise correctement mise a la terre uniquement. Voir les instructions de mise a la terre pour plus de details.









SAFETY PRECAUTIONS

For your own safety, follow all precautions in this manual.





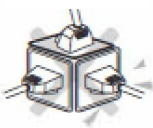





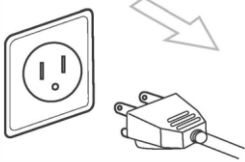

Caution: In order to avoid hazard due to inadvertent resetting of the thermal cutout, this appliance must not be attached to an external switching device, such as a timer, nor should it be connected to a circuit that is regularly switched on and off by utility.

The following symbols & terms are used in this manual to indicate hazardous scenarios with varying degrees of severity:

	DANGER	Indicates an imminently hazardous situation which, if not avoided, may result in death or serious injury.
	CAUTION	Indicates a dangerous situation that may result in injury or property damage.
	PROHIBITED	Indicates a prohibited use of the product.
	OBSERVE STRICTLY	Indicates a required step in the use of the product.

 DANGER	
 DO NOT DISASSEMBLE  <p>Never disassemble, repair or alter. Doing so may cause a fire, electrical shock, heat or a short.</p>	 WET HANDS PROHIBITED  <p>Do not plug, unplug or touch the power plug with wet hands. Doing so may cause an electrical shock.</p>
 PROHIBITED  <p>Do not use any outlet or wiring equipment beyond its specified rating. Plugging too many plugs into the same outlet, for example by using outlet splitters or adapters, can cause a fire due to overheating.</p>	 OPEN FLAME PROHIBITED  <p>Keep cigarettes and other open flames away from this product. Failure to do so may cause a fire.</p>

SAFETY PRECAUTIONS

 DANGER	
<div style="display: flex; align-items: center;">  <div style="margin-left: 10px;"> <p>DO NOT SPRAY WATER</p> </div>  </div> <p>Do not get any water or cleaning products on the main unit or power plug. Doing so may cause a fire, electrical shock, heat or a short. Doing so can cause the product to crack resulting in injury or water damage.</p>	<div style="display: flex; align-items: center;">  <div style="margin-left: 10px;"> <p>OBSERVE STRICTLY</p> </div>  </div> <p>Always unplug the product from the outlet before cleaning or maintenance. Failure to do so could cause electrical shock. This does not apply when using the Clean Nozzle function.</p>
<div style="display: flex; align-items: center;">  <div style="margin-left: 10px;"> <p>PROHIBITED</p> </div> </div> <p>Do not do anything that could damage the power cord or power plug. Do not strike, yank, twist, bend, damage heat or otherwise alter the power cords. Do not place anything heavy, bind or pinch the power cords. Using a damaged power cord may result in a fire, electrical shock, heat or short.</p>	<div style="display: flex; align-items: center;">  <div style="margin-left: 10px;"> <p>OBSERVE STRICTLY</p> </div>  </div> <p>When cleaning or maintaining plastic components or the supply hose, use mild dish soap diluted with tap water and a soft cloth. Do not use any of the following: Toilet cleaner, household cleaner, benzene, paint thinner, powdered cleanser or nylon scrubbing pads. These items could damage or crack the plastic and cause injury or malfunction. These items could damage the water supply hose and cause a water leak.</p>
<div style="display: flex; align-items: center;">  <div style="margin-left: 10px;"> <p>Do not use a loose or faulty electrical outlet. Doing so could cause a fire or short. Do not use any power supply other than the one specified (USA: AC 120V, 60Hz). Doing so could cause a fire or excessive heat. Do not touch the power plug in the event of a thunderstorm. Doing so could cause an electrical shock.</p> </div> </div>	<div style="display: flex; align-items: center;">  <div style="margin-left: 10px;"> <p>PROHIBITED</p> </div> </div> <p>Only use tap water or potable well water (underground water). Do not use seawater. Do not connect to industrial or gray water. Doing so may cause irritation to the skin and / or product malfunction.</p>
<div style="display: flex; align-items: center;">  <div style="margin-left: 10px;"> <p>PROHIBITED</p> </div> </div> <p>Only use tap water or potable well water (underground water). Do not use seawater. Do not connect to industrial or gray water. Doing so may cause irritation to the skin and / or product malfunction.</p>	<div style="display: flex; align-items: center;">  <div style="margin-left: 10px;"> <p>OBSERVE STRICTLY</p> </div> </div> <p>Make sure that a properly grounded (3 prong) outlet has been installed. Failure to install a grounded outlet could cause electrical shock in the event of a malfunction or short circuit. See Grounding Instructions for full details.</p>

SAFETY PRECAUTIONS

DANGER

BEWARE OF LOW-GRADE BURNS. Improper use of a heated seat could cause a low-grade burn. When sitting on the toilet seat for long periods of time, switch the toilet seat temperature to OFF.

Always connect the product to the cold water supply. Connecting to hot water supply may result in burns or equipment damage.

When any of the following persons use a heated seat or warm air dryer, someone should switch the seat temperature to OFF and the air drying temperature to LOW:

- Young children, elderly persons or other users unable to set the temperature appropriately themselves.
- The ill, physically disabled or other persons who do not have freedom of movement.
- Persons using any medications that may cause drowsiness.
- Those who have been drinking heavily, are otherwise intoxicated and/or are severely fatigued and anyone else liable to fall asleep during use.

SAFETY PRECAUTIONS

CAUTION

DO NOT USE THIS PRODUCT OTHER THAN FOR THE PURPOSES LISTED IN THIS MANUAL.

 **PROHIBITED**



Do not step on or stand on the toilet seat, lid or main unit. Do not apply strong force or mechanical shock. Do not place heavy objects on the toilet seat, lid or main unit. Doing so may cause injury or product damage.

 **PROHIBITED**



Do not put anything else into the toilet except for toilet paper. Doing so may cause product damage from a resulting blockage.

 **OBSERVE STRICTLY**

Do not place hands, fingers or any other object into the warm air outlet. Do not drape clothes or linens or otherwise block the warm air outlet. Doing so could cause burns, electrical shock or product malfunction.

 **OBSERVE STRICTLY**

If the product will not be in use over an extended period of time, unplug the main power cord. Leaving the power connected might cause a fire or overheating.

Do not use the product if a malfunction occurs. In the following cases, unplug the plug from the outlet and close the water supply valve. Continued use after malfunction could cause a fire, electrical shock, heat, short, injury or water damage.

Possible malfunctions:

- Water is leaking from a pipe or from the main unit.
- The product is making a strange noise or emits a strange odor.
- The product emits smoke.
- The product is abnormally hot .

Do not lift this product by the toilet seat or lid.



Do not block or interfere with the operation of the automatic seat lid opening/closing at any time. This may cause damage to the mechanism.

Do not raise the toilet seat or lid while objects are resting on top of the toilet. Doing so could cause the main unit to come loose and fall resulting in injury.

Do not fold or crush the water supply hose. Doing so could cause water leaks.

Do not use the product if the main unit is unstable. Doing so could cause the main unit to come loose and fall resulting in injury.

GROUNDING INSTRUCTIONS

This product must be grounded. In the event of an electrical short circuit, grounding reduces the risk of electric shock. The plug must be plugged into an outlet that is properly installed and grounded.

DANGER Improper use of the grounding plug can result in electric shock.

Check with a qualified electrician or serviceman if the grounding instructions are not completely understood, or if in doubt as to whether the product is properly grounded.

This product is factory-equipped with a specific electric cord and plug to permit connection to the proper electric circuit. Make sure that the product is connected to an outlet having the same configuration as the plug.

This product is for use on a nominal 120V circuit and a GFCI (ground fault circuit interrupter) receptacle is required for use with this product, as shown in Figure A below. Do not use this product with an ungrounded outlet.

Do not use an extension cord with this product. Do not use an adapter with this product. Do not modify the plug provided - if it will not fit the outlet, have the proper outlet installed by a qualified electrician. If the product must be reconnected for use on a different type of electric circuit, the reconnection should be made by qualified service personnel.

If repair or replacement of the cord or plug is necessary, do not plug into an outlet. Contact Icera's Customer Service department to discuss possible repair or replacement.

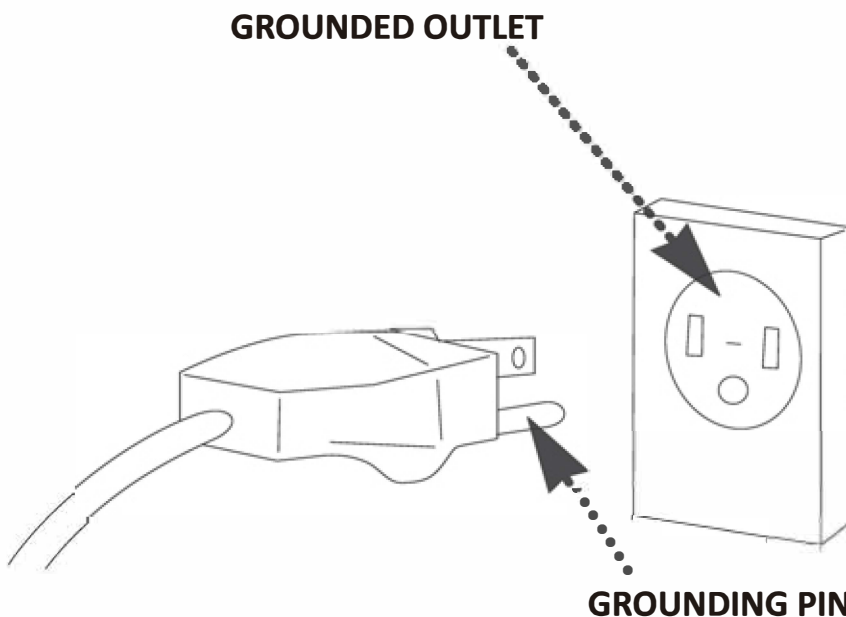
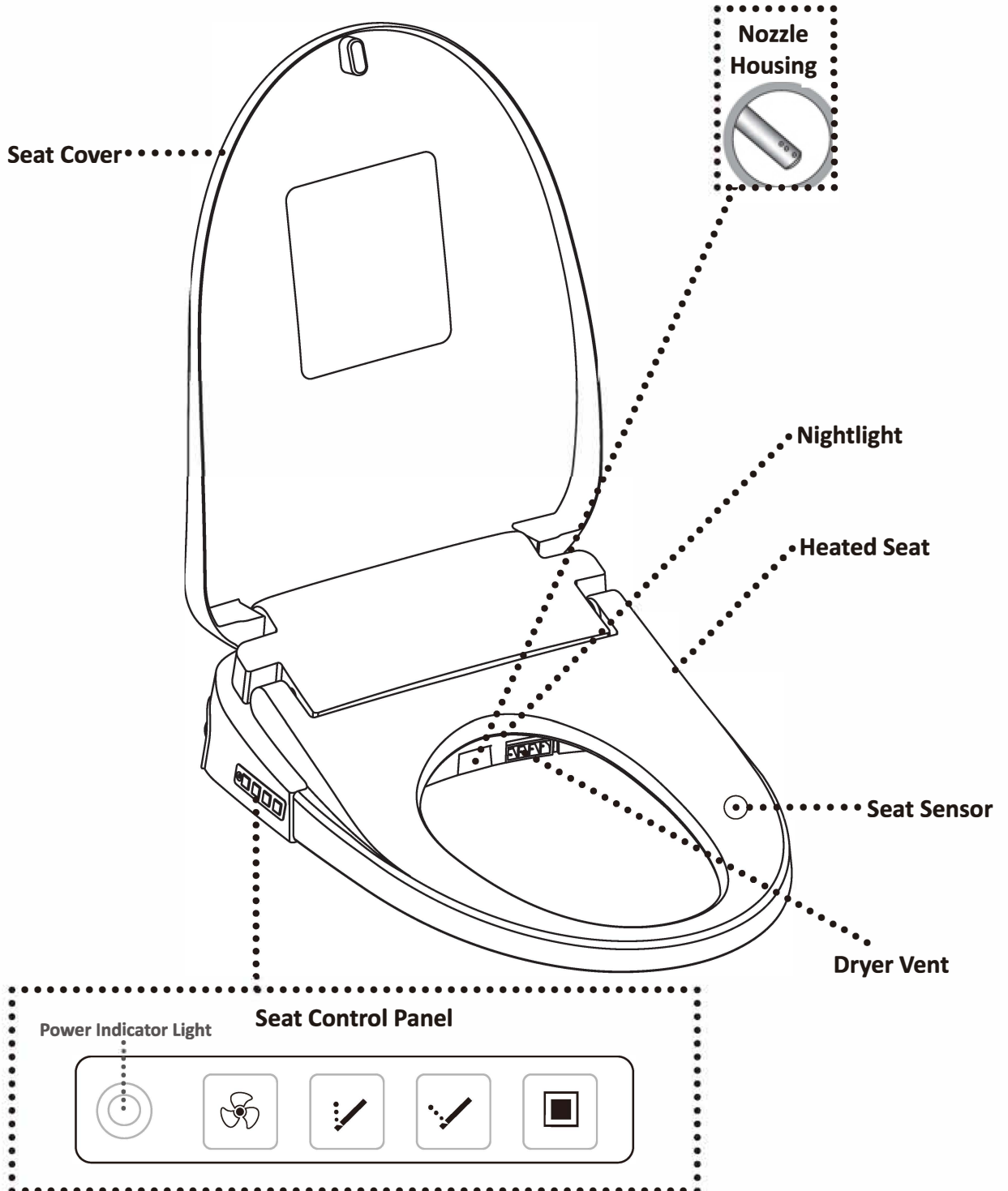

FIGURE A

PARTS IDENTIFICATION



INSTALLATION INSTRUCTIONS

CAUTION BEFORE INSTALLATION!



- Make sure all accessory parts are present.
- Do not connect the power until installation is complete.
- Ground connection should be done by authorized service person only. 120V only.
- Water pressure must be 11.6 - 108 PSI.
- Please use the water supply pipe provided for installation. Do not use the old water supply pipe. This may affect the performance of the product.
- Please do not put a cloth seat cover or cushion on this seat. This will affect performance of the product.
- In low temperature environments, please leave the product in a warm room for 2 hours prior to installation to prevent condensation from damaging the internal parts.
- Figures A and B below show the standard specifications of toilets that are compatible with this product. Please check that the size and shape of the toilet are suitable for installation.

This seat is compatible only with elongated toilets that meet the dimensional requirements below.

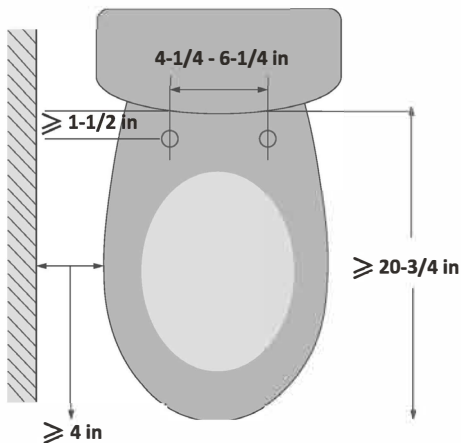

This seat is NOT compatible with toilets with arched tanks as shown below.



INSTALLATION INSTRUCTIONS

1. Remove the existing toilet seat and lid. Refer to the original seat manufacturer's instructions on how to properly remove your toilet seat. Store the old seat. Do not throw away.

2. Turn the angle stop clockwise to turn off the water supply. Flush the toilet until the toilet tank is completely drained.

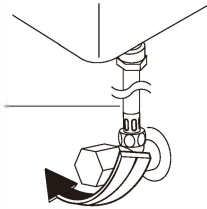

3. Detach the existing water supply hose from the toilet tank and angle stop.

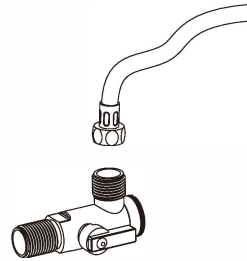

4. Connect the t-valve to the wall angle stop. Do NOT overtighten!

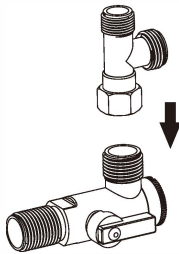

5. Connect the old water supply line and the braided steel transfer hose to the t-valve.

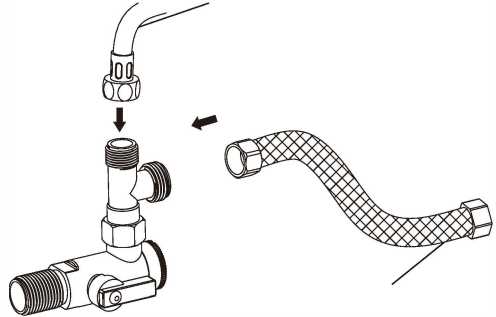

6. Connect the water supply line to the toilet inlet. Connect the transfer hose to the seat inlet.

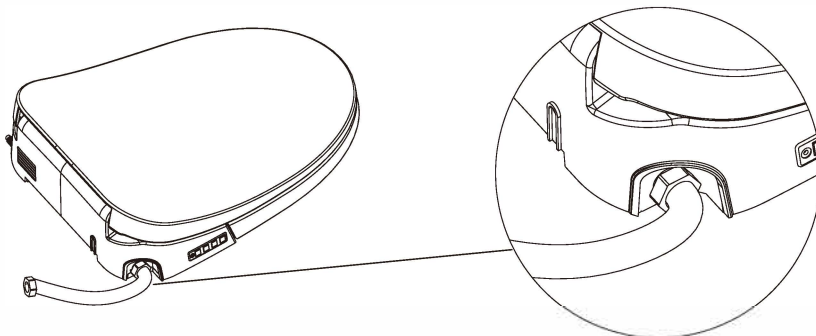

INSTALLATION INSTRUCTIONS

7. Insert the bolt anchors into the bolt holes on the toilet deck.

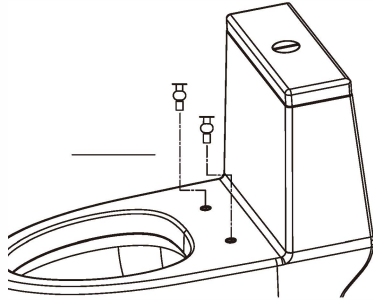

8. Fasten the mounting plate to the bowl with the provided bolt assembly.

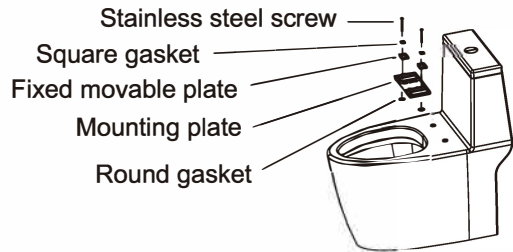

9. Center the seat to the mounting plate and slide the seat towards the toilet tank. Listen for a click that will indicate that the seat is properly connected to the plate.

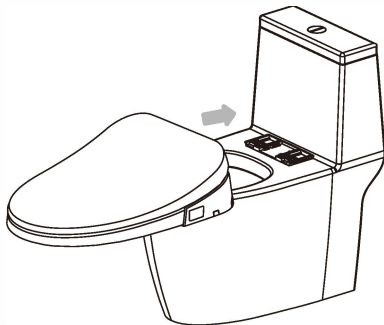

10. Lightly move the seat side-to-side and back-and-forth. The seat should not come off when moved lightly.

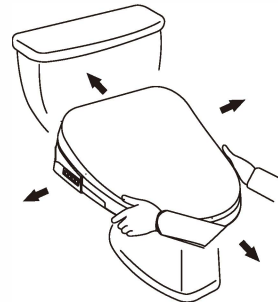

11. Turn the water supply valve counterclockwise to re-allow water flow.

12. Connect the power cord to a 120V grounded outlet to begin use.

TO DISASSEMBLE: Turn off water supply. Disconnect water supply hose and transfer hose. Press the removal button on the side of the seat and pull the seat forward until it is separated from the toilet.

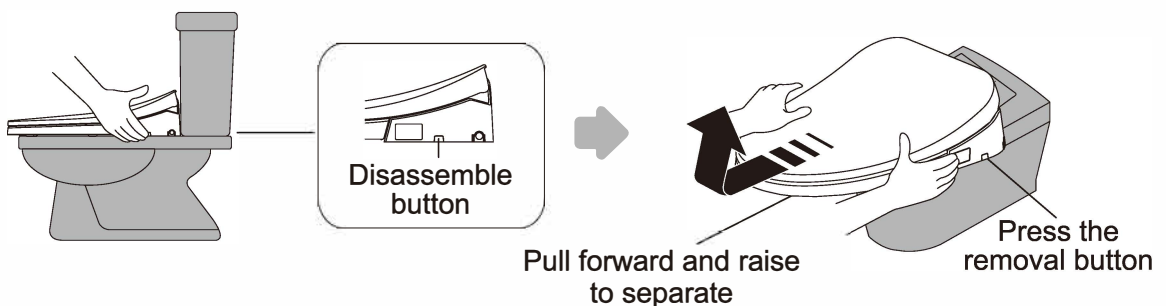

iWASH S-12 FEATURES & REMOTE GUIDE

Ensure your seat is plugged in. If the power indicator light on the side panel are on, your seat is ready to use.

LED bars instruction: 1st bar: Flashes when water/seat/dryer settings are engaged and ready to be adjusted. 2nd bar: room temperature (level 1). Remaining bars light up as the levels are adjusted upwards.

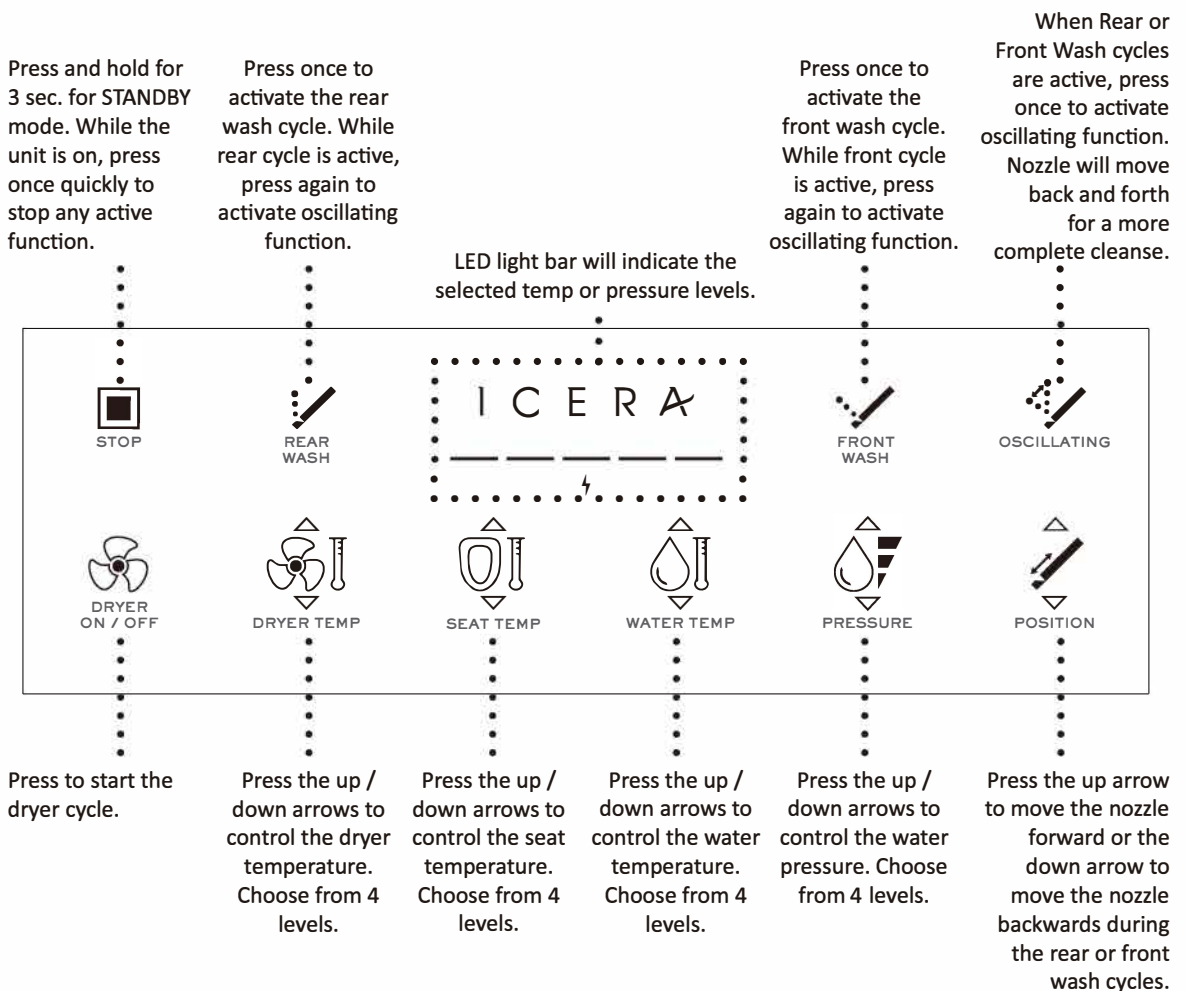

iWASH S-12 FEATURES & REMOTE GUIDE

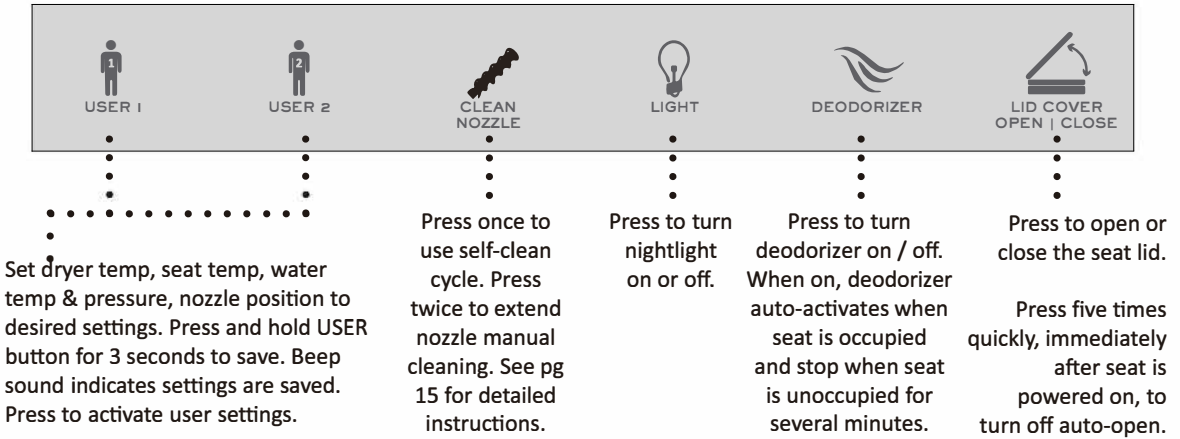

iWASH S-12 SEAT PANEL GUIDE

If your iWash remote is not operational (e.g., lost, dead batteries, damaged or otherwise not working), the basic wash functions of your bidet seat can be controlled from the seat panel located on the left-side of the seat (when facing the unit from the front). These controls will only activate or stop the spray and dryer functions. Temperature, pressure and nozzle position settings cannot be changed using the seat panel controls. All temperature/ pressure levels and nozzle position will default to the last used settings engaged by the remote control. The Power Wash function cannot be activated using the seat panel controls.

Contact Icera Customer Service at 855-444-2372 or service@icerausa.com, if a replacement remote is needed.

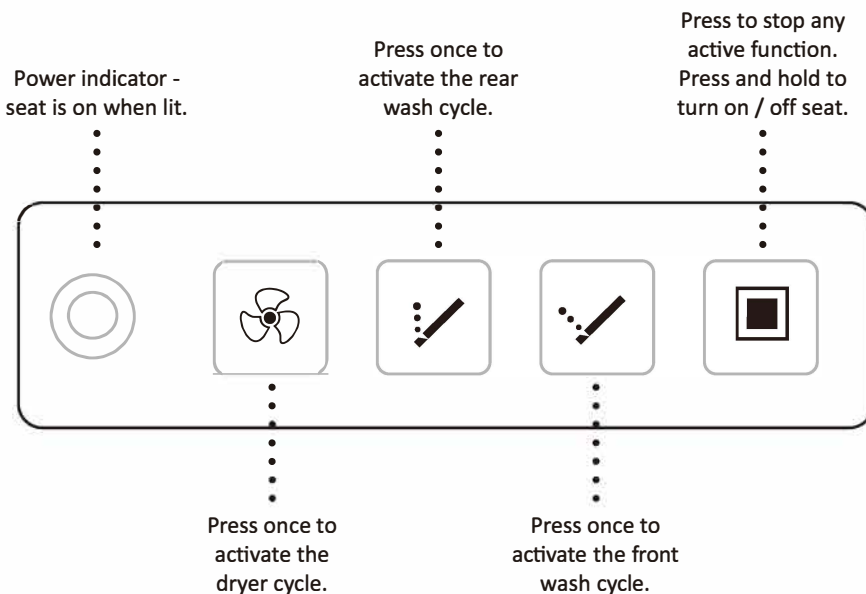

CLEANING YOUR iWASH

**For your safety, make sure the seat is powered OFF
AND unplugged before cleaning.**

CLEANING THE WATER FILTER

- Turn off the water supply by turning the wall angle stop clockwise.
- Detach the transfer hose from the t-valve and the seat. Remove the mesh filters from both ends of the hose.
- Rinse the mesh filters. Clean the valve gently with a soft brush.
- Re-insert the filters and reattach the transfer hose. Turn on water supply by turning the wall angle stop counterclockwise.

CLEANING THE BIDET NOZZLE

FOR SELF-CLEAN FUNCTION:

- Press the CLEAN NOZZLE button on the top of the remote control twice to active the self-clean function.
- The self-clean cycle will activate for 15 minutes. Press STOP button to end cycle early.
- Do not push or pull the nozzle while the self-clean function is active.

FOR MORE EXTENSIVE MANUAL CLEANING:

- Press the CLEAN NOZZLE button once to extend the nozzle.
- Clean the nozzle gently with a soft brush.
- Do not pull the nozzle out or exert force while cleaning. This may cause product damage.
- Press the STOP button on the remote to return the nozzle to its resting position.

EXTERNAL CLEANING

- The external casing of the seat is made of a plastic that may be damaged by coarse brushes / pads, harsh chemicals, etc. Test any household cleaner on a inconspicuous area before using. Do not use toluene, mineral oil, heptane and nitric, chromic or sulfuric acids to clean this product.
- Unplug before cleaning. Do not splash water on the plug or outlet.
- Clean with a soft, wet cloth. Wring out excess water from the cloth before cleaning.
- Do not spray water onto the unit.

**WARNING: TOUCHING THE PLUG OR OUTLET WITH WET HANDS
MAY RESULT IN ELECTRIC SHOCK.**

TROUBLESHOOTING GUIDE

ISSUE	POSSIBLE CAUSES	SOLUTION
Seat does not work at all.	The seat sensor is covered by cloth or any other object. Sensor must be activated by skin contact in order for most functions of the seat to work.	Remove any fabric or object blocking the seat sensor.
	Plug is loose or poor connection.	Make sure the plug is securely plugged into the outlet.
	The power indicator light is off.	If the power indicator light is off, press the stop button on the remote or side panel to turn the unit back on.
	Power is out.	This seat is fully electronic. Power must be on in order for seat to work.
Spray functions not working.	Filter is clogged.	Clean the filter. See page 15 for instructions.
Spray pressure is not strong enough.	Water pressure is set at lowest level.	Increase the water pressure using the remote control.
	Filter is clogged.	Clean the filter. See page 15 for instructions.
	Nozzle is clogged or dirty.	Clean the nozzle. See page 15 for instructions.
Spray is not warm enough.	Water temperature is set at lowest level.	Increase the water temperature using the remote control.
Seat is not warm.	Seat temperature is set at lowest level.	Increase the seat temperature using the remote control.
Remote control is not working.	Batteries are dead or inserted incorrectly.	Check that the batteries are inserted correctly and test. Replace if necessary.
	Seat is unoccupied.	Most functions will not work if the seat is unoccupied. Make sure the seat sensor is being engaged. See Parts Identification for sensor location.
	Remote is not properly paired with the seat.	See page 17 for remote pairing instructions.

PAIRING YOUR REMOTE

If your remote control is failing to activate functions on your seat, it is possible that it will need to be re-paired with your seat. Follow the steps below to pair your remote control with your bidet seat.

- Power off your bidet by unplugging the power plug.
- Press and hold the STOP button and CLEAN NOZZLE button on your remote simultaneously for 3 seconds until the indicator lights under the ICERA logo on your remote are on and flashing.
- Power on your bidet by plugging the power plug back in.
- Check your remote. If the 4th and 5th indicator lights under the Icera logo on your remote are lit, you have successfully paired your remote with your bidet seat.
- If the indicator lights are not lit, try the steps above again after 15 seconds.
- Please email service@icerausa.com if you are unable to pair your remote with your seat.

PRODUCT SPECIFICATIONS

ITEM		SPECIFICATION	
Rated Voltage		110-120V	
Rated Frequency		60 Hz	
Rated Power		1100W (59°F - 34°F inlet water temperature)	
Water Supply Mode		Direct connection to water supply	
Ambient Temperature		37.4°F - 104°F (3°C - 40°C)	
Water Supply Temperature		37.4°F - 95°F (3°C - 35°C)	
Water Pressure Range		11.6PSI - 108.8PSI	
Safety Device		Seated sensor, water over-pressure protection device	
Bidet Spray	Heating Method		Ceramic instant heating
	Warm Water Temperature		4 Levels - Room temp to 104°F (40°C)
	Spray Volume	Rear Wash	Maximum 1000cc
		Front Wash	
	Heater Capacity		1100W
Safety Device		Temperature sensor, temperature fuse, temperature jumper, flow meter	
Dryer	Dryer Temperature		4 Levels - Room temp to 104°F (40°C)
	Heater Capacity		250W
	Safety Device		Double-sheet-metal switch, temperature fuse
Deodorizer	Deodorization		Activated carbon
	Power Consumption		1.5W
Heated Seat	Seat Temperature		4 Levels - Room temp to 104°F (40°C)
	Heater Capacity		28W
	Safety Device		Temperature sensor, temperature fuse
	Closure		Seat and cover with slow-close mechanism

WARRANTY INFORMATION

3-YEAR LIMITED WARRANTY

For electronic bidet seats and integrated bidet toilet seats, Icera provides a warranty against defects in material and workmanship limited to three (3) years from the date of purchase. Scratching, staining, and other effects from chemical use, water, and atmospheric conditions are not considered manufacturing defects but are considered normal wear and tear. Use of the bidet seat with non-confirming electricity supply / water supply pressure, outside of the specified supply parameters, will void the warranty.

IMPORTANT!

Icera is not responsible for removal or installation costs.

The above warranty is extended only to the original purchaser of the product(s). This warranty is non-transferable. Proof of purchase is required for all warranty claims. This warranty is voided and does not apply where items have been improperly stored, damaged or improperly installed.

Icera reserves the right to inspect claimed defective products. Icera will, at its election, repair, replace or make appropriate adjustment where Icera inspection discloses any such defects occurring in normal usage within the warranty period after purchase. Comparable products will be offered as replacements for products not then available. Some replacement parts may vary from those originally supplied and are subject to availability.

Warranties are not applicable to products sold by unauthorized resellers. The consumer accepts responsibility to research the integrity and reputation of the reseller to ensure they are authorized to sell and provide appropriate pre purchase and post purchase service. Internet resellers should be particularly scrutinized as they are very difficult to evaluate and often provide very limited or no customer service.

This warranty applies to unmodified products when properly installed and maintained per factory instructions for their normal and intended application. Icera highly recommends installation by a licensed professional plumbing contractor. To obtain service or to purchase replacement parts not covered by the above warranty, contact your local Icera dealer.

Icera reserves the right to make changes in product design, manufacturing process, packaging, or availability at any time without notice.

Implied warranties including that of merchantability and fitness for a particular purpose are limited to the duration of this warranty. Icera and/or dealer expressly disclaims any liability for special, incidental or consequential damages.

Some states/provinces do not allow limitations on how long an implied warranty lasts, or the exclusion or limitation of special, incidental or consequential damages, so these limitations and exclusions may not apply to you. This warranty gives you specific legal rights. You may also have other rights which vary from state/province to state/province.

This is Icera's exclusive written warranty. This exclusive written warranty is issued in lieu of all other warranties, expressed or implied, including but not limited to the implied warranties of merchantability and fitness for a particular purpose.

**ICERA USA
16341 Carmenita Rd.
Cerritos, CA 90703**

**P: 855-444-2372
E: service@icerausa.com
W: www.icerabath.com**